

HandiClamp

OD44 to OD360

- Single Band Repair Clamp
- Giunto di riparazione a singola fascia
- Jednodílný Opravný Třmen



GB – INSTALLATION INSTRUCTIONS



CZ – MONTÁŽNÍ NÁVOD



I – ISTRUZIONI PER L'INSTALLAZIONE



PIONEERS IN PIPE SOLUTIONS

CRANE

BUILDING SERVICES & UTILITIES



Single Band Repair Clamp

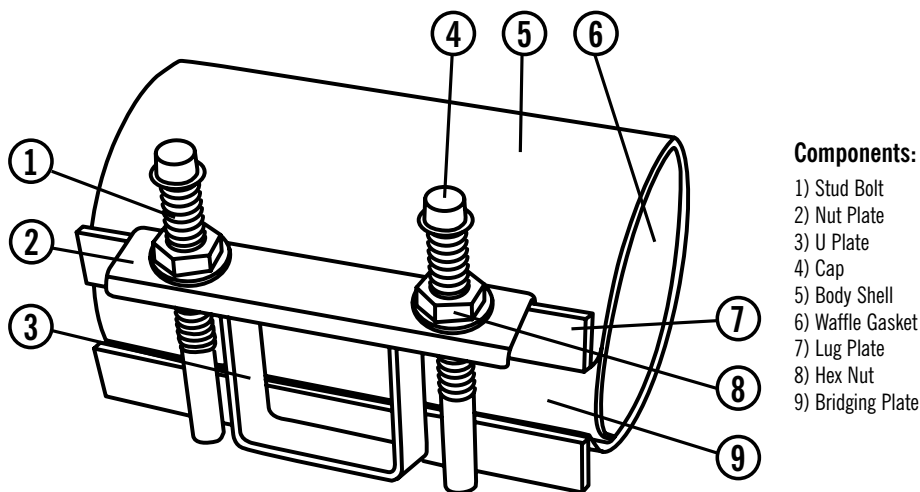

Components:

- 1) Stud Bolt
- 2) Nut Plate
- 3) U Plate
- 4) Cap
- 5) Body Shell
- 6) Waffle Gasket
- 7) Lug Plate
- 8) Hex Nut
- 9) Bridging Plate

- 1) Check that the actual outside diameter of the damaged pipe falls within the range of the HandiClamp selected (Fig 1) + (Fig 2).
- 2) Clean the outside of the pipe, and:
 - i) Brush off any loose dirt.
 - ii) Ensure all exposed edges from the hole, crack or gouge in the pipe are flush with the pipe OD.
 - iii) Loosen the hex nuts (8) as far as the protection caps (4) (fig 3).
- 3) Unhook the nut-plate (2) and open the fitting (Fig 3).

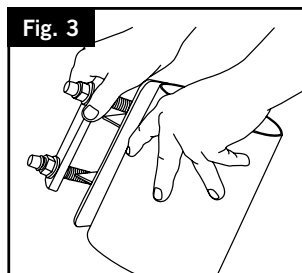
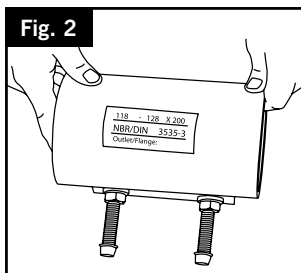
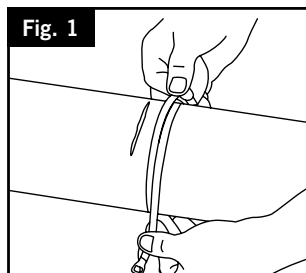



4) Install the HandiClamp on the pipe some distance away from the damaged area:

- i) Wrap HandiClamp around pipe (Fig 4).
- ii) Close the clamp by pulling the U-plate (3) towards the (opposite) lug-plate (7) and hooking the nut-plate over the lug-plate (Fig 5).
- iii) Loosely tighten the hex nuts (8) to hold nut plate in position (Fig 6).

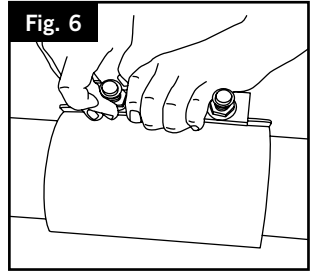
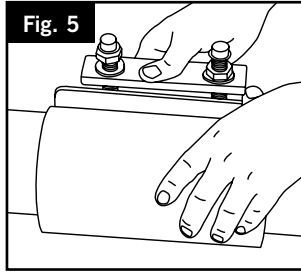
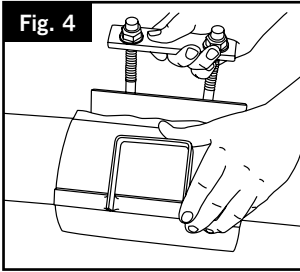

5) Install the HandiClamp over the damaged section of pipe:
Slide the fitting over the damaged section of pipe, ensuring that it is centralised over the damaged area (Fig 7).

6) Tighten the nuts evenly to the recommended bolt torque (Fig 8) (see table).

7) Finally, check that correct bolt torque has been achieved (Fig 9).

Bolt Size	Torque Nm
M12	55 - 70
M14	70 - 85
M16	95 - 110

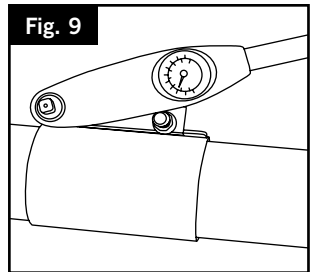
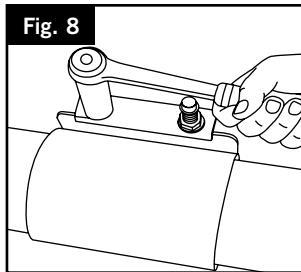
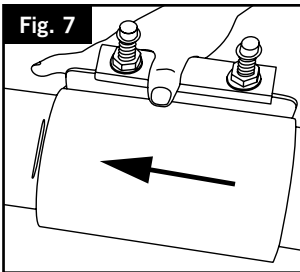



Giunto Di Riparazione a Singola Fascia

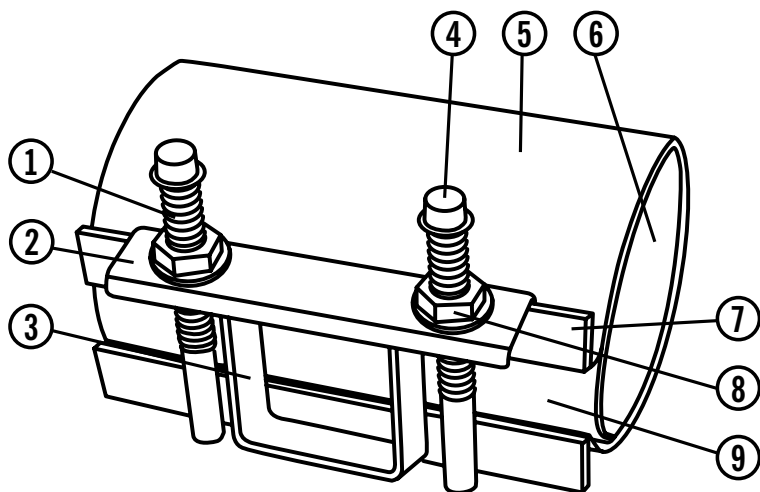

Componenti:

- 1) Bullone prigioniero
- 2) Piastra filettata
- 3) Piastra a U
- 4) Calotta
- 5) Guscio
- 6) Guarnizione sagomata
- 7) Piastra con alette
- 8) Dado esagonale
- 9) Ponte

- 1) Controllare che la tubazione da riparare sia compatibile con le dimensioni coperte dalla gamma Handiclamp (Fig.1) + (Fig.2).
- 2) Pulire la superficie esterna del tubo e:
 - i) Eliminare ogni traccia di terra.
 - ii) Verificare che tutti i bordi esposti del foro, della fenditura o dell'incavo presente sul tubo siano a livello del diametro esterno del tubo.
 - iii) Allentare i dadi esagonali (8) fino alle calotte di protezione (4) (fig. 3).
- 3) Liberare la piastra filettata (2) e aprire il raccordo (Fig. 3).

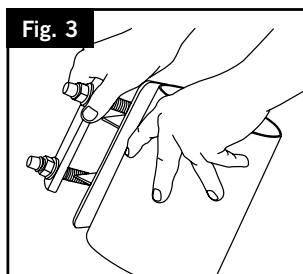
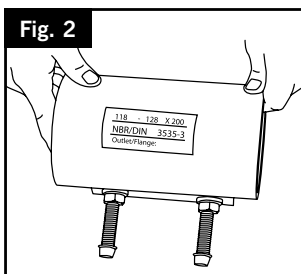
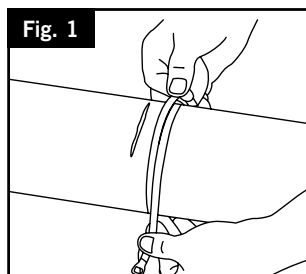

4) Installare HandiClamp sul tubo a una certa distanza dall'area danneggiata:

- i) Avvolgere HandiClamp intorno al tubo (Fig. 4).
- ii) Chiudere il giunto tirando la piastra a U (3) verso la piastra ad alette (lato opposto) (7) e fissare la piastra filettata sulla piastra di blocco (Fig. 5).
- iii) Stringere i dadi esagonali (8) senza bloccarli per tenere in posizione la piastra filettata (Fig. 6).

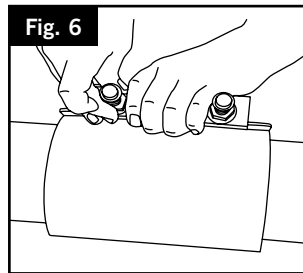
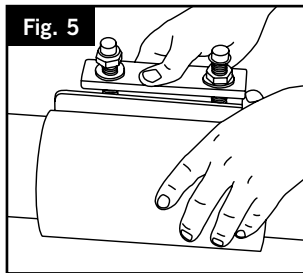
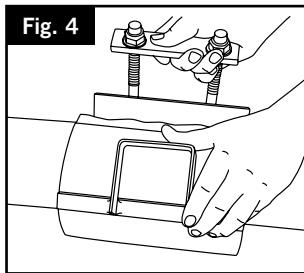

5) Installare HandiClamp sulla sezione danneggiata del tubo: Far scorrere il raccordo sulla sezione danneggiata del tubo, verificando che sia centrato sull'area danneggiata (Fig. 7).

6) Serrare i dadi uniformemente applicando la coppia di serraggio raccomandata per i bulloni (Fig. 8) (vedere tabella).

7) Infine, controllare di avere raggiunto la coppia di serraggio corretta per i bulloni (Fig. 9).

Misura dei bulloni	Coppia di serraggio Nm
M12	55 - 70
M14	70 - 85
M16	95 - 110

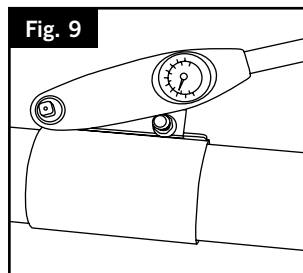
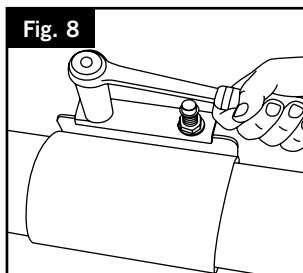
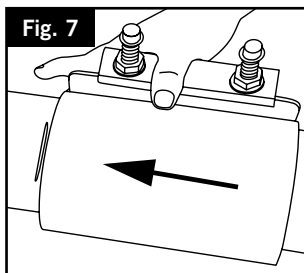



Jednodílný Opravný Třmen

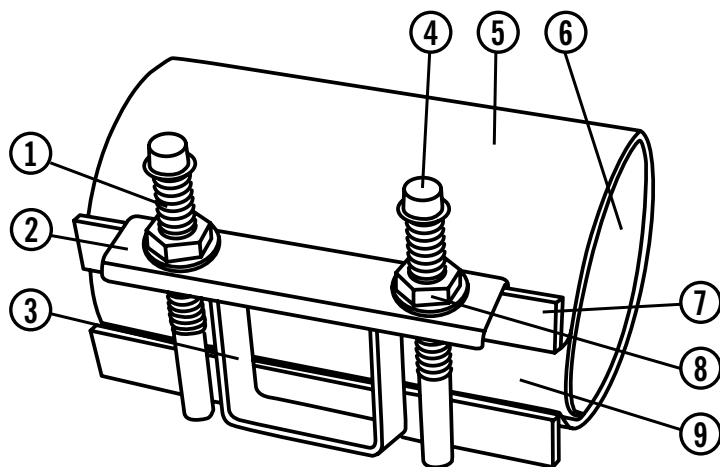

Součásti :

- 1) Šroub
- 2) Maticový plech
- 3) U plech
- 4) Krytka
- 5) Těleso
- 6) Vaflové těsnění
- 7) Zarážkový plech
- 8) Šestihránná matice
- 9) Můstkový plech

- 1) Zkontrolujte, zda skutečný vnější průměr poškozené trubky spadá do rozsahu vybraného třmenu HandiClamp (obr. 1) + (obr. 2).
- 2) Očistěte vnější stranu potrubí, a dále pak:
 - i) Odstraňte kartáčem všechny nečistoty.
 - ii) Zajistěte, aby všechny obnažené hrany z otvoru, praskliny nebo rýhy v potrubí nepřesahovaly jeho vnější průměr.
 - iii) Uvolněte šestihránné matice (8) a ochranné krytky (4) (obr. 3).
- 3) Vyhákněte maticový plech (2) a rozevřete třmen (Obr. 3).

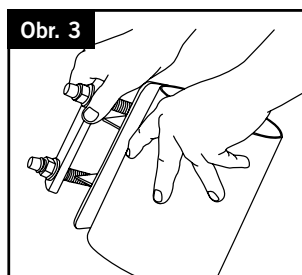
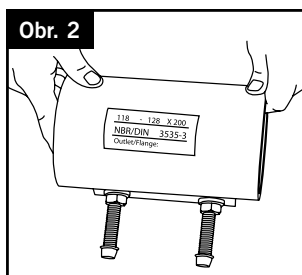
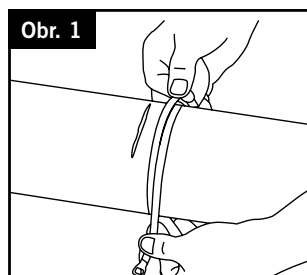

4) Nasadíte HandiClamp mimo poškozenou oblast potrubí:

- i) Oviňte HandiClamp kolem potrubí (Obr. 4).
- ii) Uzavřete třmen tahem za U- plech (3) směrem k (protilehlému) zarážkovému plechu (7) a zahákněte maticový plech přes zarážkový plech (Obr 5).
- iii) Lehce dotáhněte šestihřanné matice (8) tak, aby držely maticový plech (Obr. 6).

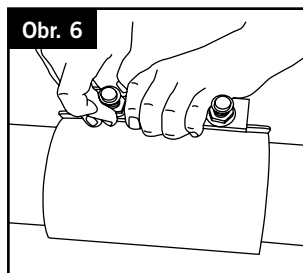
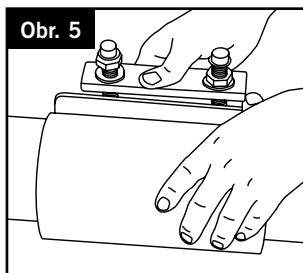
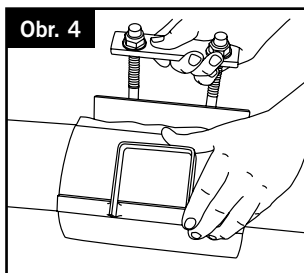

5) Přesuňte HandiClamp na poškozené místo potrubí a ujistěte se, že je třmen na tomto místě vystředěn.

6) Dotáhněte matice rovnoměrně doporučeným utahovacím momentem (Obr. 8) (viz tabulka).

7) Nakonec zkontrolujte, že bylo dosaženo správného utahovacího momentu.

Velikost šroubu	Utahovací moment
M12	55 - 70
M14	70 - 85
M16	95 - 110

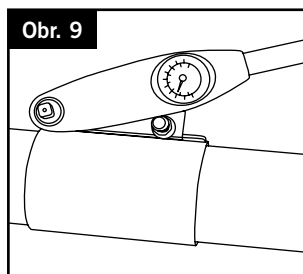
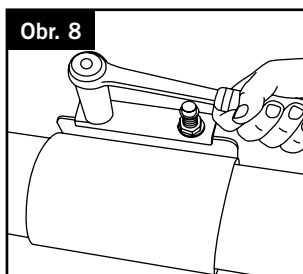
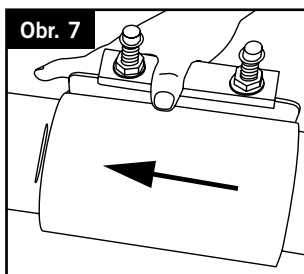

Every effort has been made to ensure that the information contained in this publication is accurate at the time of publishing. Crane Ltd assumes no responsibility or liability for typographical errors or omissions or for any misinterpretation of the information within the publication and reserves the right to change without notice.

Byla vynaložena veškerá snaha k zajištění přesných informací obsažených v této publikaci v čase jejího vydání. Crane Ltd nepřebírá žádnou zodpovědnost nebo právní odpovědnost za typografické chyby nebo opomenutí nebo za jakýkoli mylný výklad těchto informací z této publikace a vyhrazuje si práva změny bez oznámení.

È stato applicato il massimo impegno per garantire che le informazioni contenute nel presente documento siano accurate al momento della pubblicazione. Crane Ltd declina ogni responsabilità per eventuali omissioni o errori tipografici o qualsivoglia interpretazione errata delle informazioni contenute nella pubblicazione e si riserva il diritto di modifica senza preavviso.

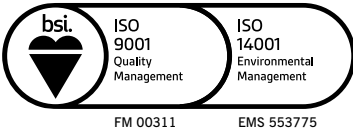

www.vikingjohnson.com/handrange



To visit our Video Library go to:
K návštěvě naší video knihovny jděte na:
Per visitare la libreria video accedere a:
<http://www.youtube.com/user/CraneBSU>



46-48 WILBURY WAY
HITCHIN,
HERTFORDSHIRE
SG4 0UD. UK

TELEPHONE: +44 (0)1462 443322
FAX: +44 (0)1462 443311
EMAIL: info@vikingjohnson.com
www.vikingjohnson.com

DR1.00200C_07_01_2019_REV04_R39/050Y

PIONEERS IN PIPE SOLUTIONS